

SPECIFICATION SHEET for AMMONIA SENSOR with FAST RESPONSE TYPE NH3/CR-200

PERFORMANCE CHARACTERISTICS

Nominal Range	0 – 100 ppm
Maximum Overload	200 ppm
Expected Operation Life	2 years in air
Output Signal	90 ± 18 nA/ppm
Resolution	1 ppm
Temperature Range	- 10 °C to 40 °C
Pressure Range	Atmospheric ¹⁾
Pressure Coefficient	No data
T ₉₀ Response Time	< 50 sec
Relative Humidity Range	15 % to 90 % R.H. non-condensing
Baseline	0 ppm ± 4 ppm
Maximum Zero Shift (+20°C to +40°C)	-8 ppm
Typical Long Term Output Drift	< 5% per 6 months
Recommended Load Resistor	10 Ohm
Bias Voltage	Not allowed
Repeatability	< 3 % of signal
Output Linearity	< 5 % full scale
Humidity Effect ²⁾	< 4 ppm

¹⁾ no data for deviations

²⁾ abrupt changes in rel. humidity causes a short term transient signal

CROSS-SENSITIVITY DATA

Interfering Gas	Concentration	Reading
CO	300 ppm	0 ppm
H ₂	200 ppm	0 ppm
SO ₂ ³⁾	20 ppm	-7 ppm
H ₂ S ³⁾	20 ppm	7 ppm
NO ³⁾	20 ppm	-1 ppm
NO ₂ ³⁾	20 ppm	-20 ppm
Cl ₂	20 ppm	-55 ppm
CO ₂	2 %	0 ppm

³⁾ Long term exposures and high concentrations may affect the performance characteristics

Performance data conditions:
20 °C, 50% RH and 1013 mbar

PHYSICAL CHARACTERISTICS

Weight	~ 13 g
Position Sensitivity	None
Storage Life	Six months in container
Recommended Storage Temperature	5 °C – 20 °C
Warranty Period	12 months from date of dispatch

Compact-Size Outline Dimensions

BOTTOM VIEW

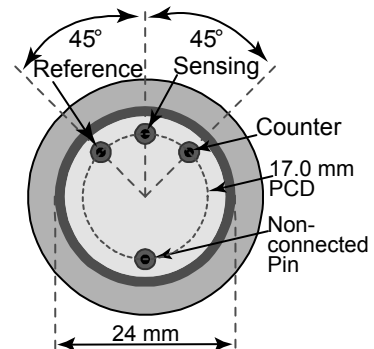

SIDE VIEW

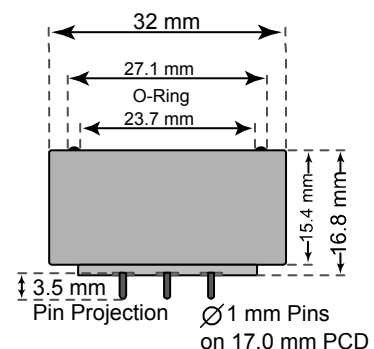

APPLICATIONS

Leak Detection
Safety and Environmental Control

SPECIFICATION SHEET for AMMONIA SENSOR with FAST RESPONSE TYPE NH3/CR-200

TEMPERATURE DEPENDENCE

The output of an electrochemical sensor varies with temperature. The graphs below show the variation in output with temperature for this type of sensor. The results are shown in the graphs as a mean for a batch of sensors, along with confidence intervals corresponding to ± 3 times the standard deviation. The sensitivity dependence is expressed as a percentage of the signal at 20 °C. The shift in baseline is shown in ppm referenced to 20 °C.

Sensitivity Temperature Dependence

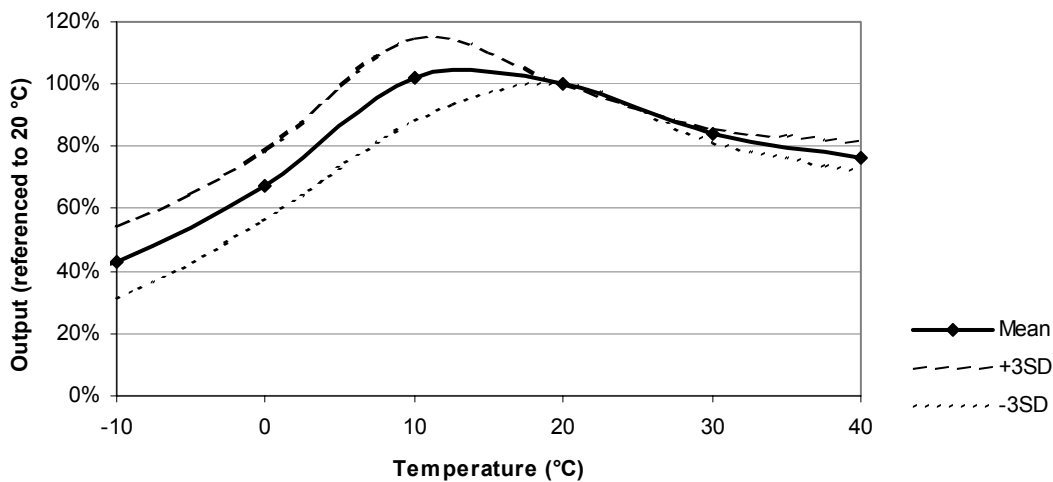

Baseline Temperature Dependence

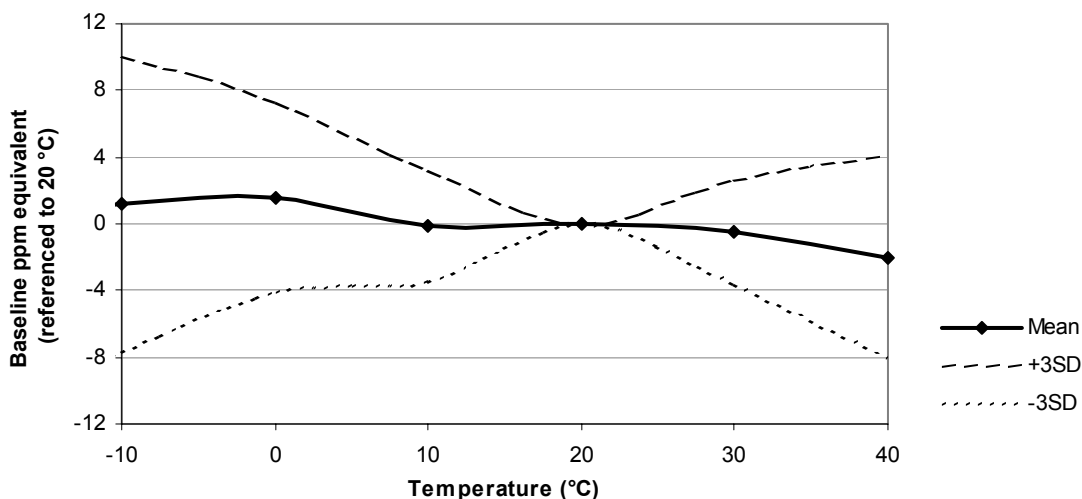

The data contained in this document is for guidance only. Membrapor AG accepts no liability for any consequential losses, injury or damage resulting from the use of this document or the information contained within it. The data is given for guidance only. Customers should test under their own conditions, to ensure that the sensors are suitable for their own requirements.