

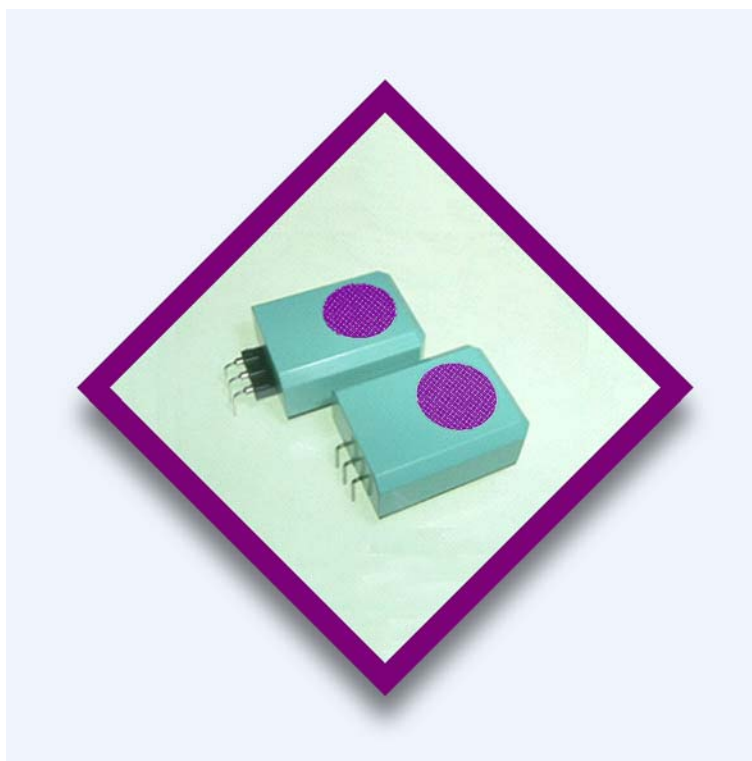

- NEMOTO SENSORTECH DIVISION
- NANO & CYBERTECH DIVISION

USER MANUAL & CHARACTERISATION DATA

NT-CO-2F Electrochemical Carbon Monoxide Gas Sensor



Head Office: **N.E.T.** Srl Via Legnano 2 – 20010 Cornaredo, Milan, ITALY
Tel: (+39) 02 935 44190 Fax: (+39) 02 935 40347
WEB: www.nemototech.com E-MAIL: info@nemototech.com



INTRODUCTION

Nemoto & Co. Ltd was established in 1941 and continues to develop unique technologies for the Safety, Security and Health markets. Using our unique experience of fine chemical preparation and printing, we were able to enter the gas sensor market in 1979 with a range of high-quality hot-wire type sensors (pellistors). Nemoto is now one of the World's leading manufacturers of chemical sensors and has so far delivered over 30-million devices to the market.

As a result of three-years' development at our Tokyo R&D centre, we released our first electrochemical sensor, for the monitoring of toxic gases, in 2000.

The NT-CO-2F Gas Sensor is a new 3-Electrode Electrochemical cell specifically designed use in low-cost disposable "pocket clip" type personal monitors. The sensor detects and measures the presence of Carbon Monoxide in the range 0-1000ppm, allowing health and safety alarms to be set at internationally recognised occupational exposure levels. The Internal Electrode structure has been optimised for maximum stability during the sensor's 2 year working lifetime, recognising that the complete instrument including the sensor will be disposed of after this time.

By using our experience of design for manufacture and our high volume production facilities in Japan and China, we have successfully reduced the cost of the NT-CO-2F whilst being able to maintain the highest performance quality.

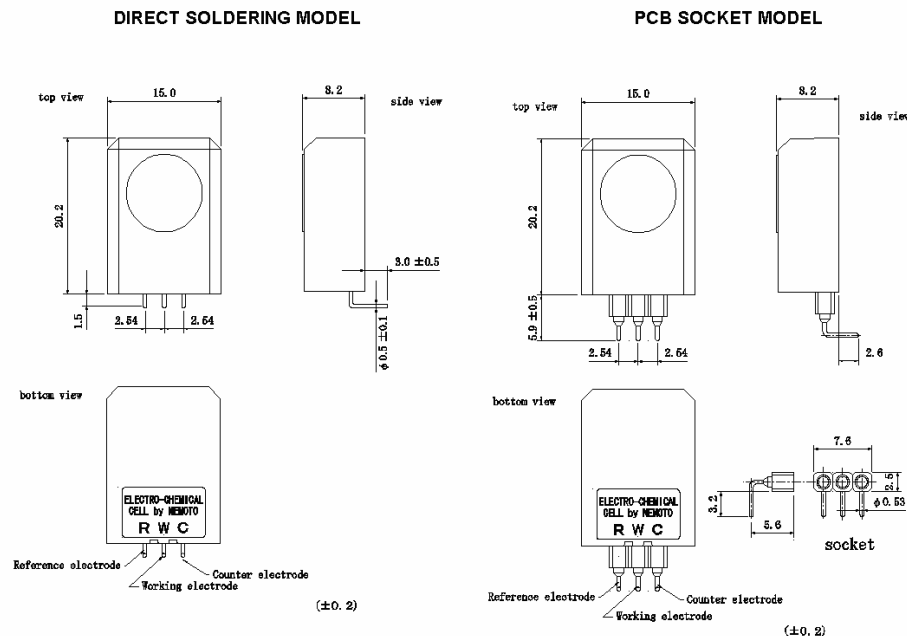

This characterisation document does not constitute a specification but is intended as a guide, informing the instrument designer of the performance characteristics of the sensor which were observed by Nemoto Environmental Technology's Engineers.

It should be read in conjunction with Technical Information Sheet ds-ntco2f.doc, which includes the full technical specification for the NT-CO-2F Gas Sensor.



PRINCIPLES OF OPERATION

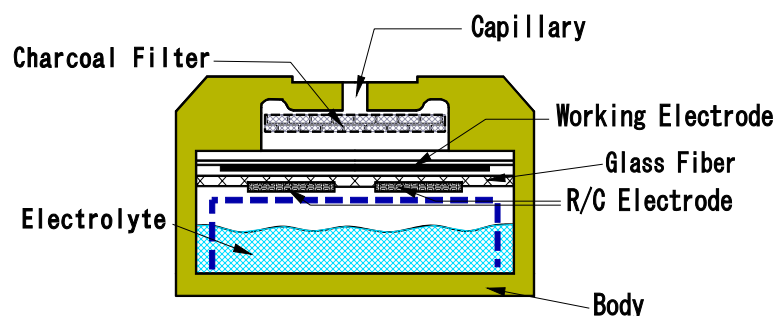

The NT-CO-2F consists of 3 porous noble metal electrodes separated by an acidic aqueous electrolyte, housed within a plastic (PPO) enclosure. Gas enters the cell via a gas phase diffusion barrier (capillary) and a chemical based filter that removes unwanted gases which might interfere with the sensors performance or give a false signal. An electrolyte reservoir ensures an excess of electrolyte is available at all times, and the sensor is vented to ensure that the internal and external pressure of the sensor is in equilibrium.

In operation, gas enters the cell via the capillary and filter, and comes into contact with the 'working' electrode. Any carbon monoxide present undergoes the following (oxidation) reaction:

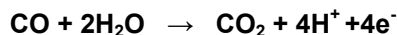

The CO_2 generated vents away from the cell via the capillary, whilst the hydrogen ions (H^+) migrate into the electrolyte within the cell. The electrons (e^-) generated at the working electrode are collected by the external circuit via a metal strip in contact with it, in the form of a small (nA) electric current.

The reaction at the working electrode is balanced by a reciprocal (reduction) reaction at the 'counter' electrode, using Oxygen from the surrounding atmosphere.

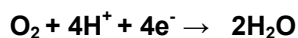

The electrons consumed in this reaction are supplied by the external circuit via a metal strip in contact with the counter electrode.

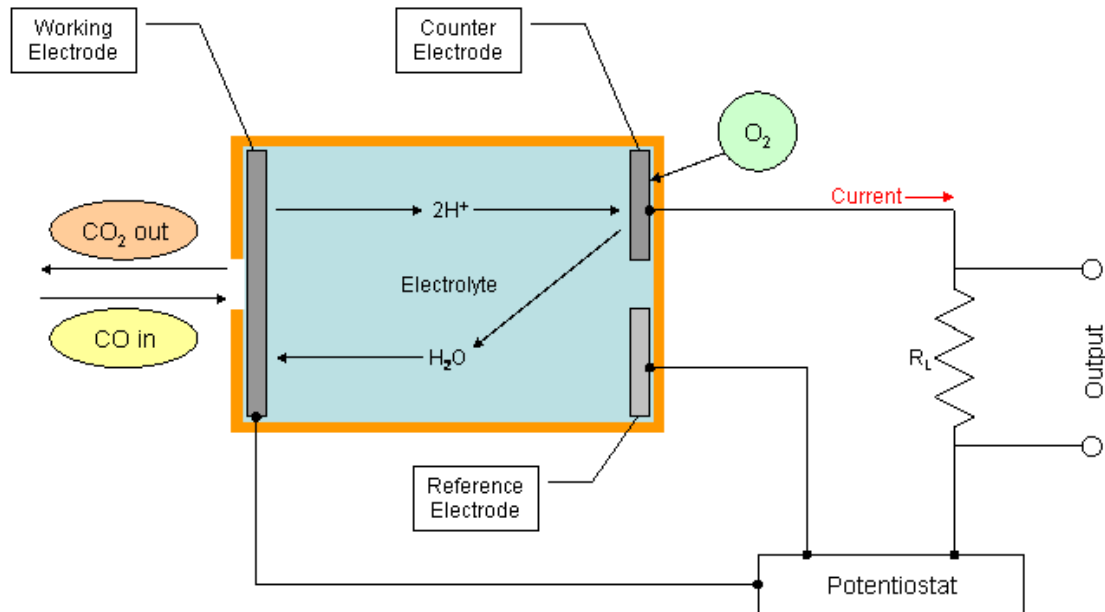

Thus water is consumed whilst Hydrogen ions are generated at the working electrode, whilst the water is re-created and hydrogen ions are consumed at the counter electrode. At the same time, the reaction at the working electrode generates electrons, whilst the reaction at the counter electrode consumes electrons. By connecting the working and counter electrodes together via a special circuit, flow of electrons between the two electrodes is measured as a nA level current signal proportional to the carbon monoxide concentration.

The 'reference' electrode maintains the healthy operation of the cell. It is surrounded by electrolyte, sees no gas and no current is allowed to be drawn from it. Its electrochemical potential hence always remains constant at a level known as the "rest air potential" and this is used to regulate the potential of the working electrode, regardless of the current it is generating during operation. The use of a reference electrode in this way (i.e. three-electrode operation) helps to extend the working range of the sensor, improves linearity and results in a number of performance benefits compared with similar sensors working with 2-electrodes only.



FEATURES

Electrochemical gas sensors have the following superiority to conventional semiconductor type and hot-wire type gas sensors.

- **Linear output in proportion to gas concentration**
- **High reproducibility**
- **Highly gas specific**
- **Unaffected by humidity**
- **Stable output for long periods**
- **Low power consumption because no heater is used (can be battery operated)**
- **Small and lightweight (can be used in portable devices)**
- **No mechanical structure so highly resistant to shocks and vibrations.**

NT-CO-2F has been developed from our accumulation of technologies in production of hot-wire type gas sensors, long research experience into catalysts, fine printing, and assembling of sensors. The NT-CO-2F is small and less-expensive, but has high sensitivity, long life, and leak-free performance even under severe operating conditions.

Small-size

NT-CO-2F is one of the smallest electrochemical sensors in the world to accommodate the design and manufacture of smaller gas detection products and allowing space for additional features.

Air vent

The electrolyte used for chemical sensors is very hygroscopic, i.e. it has affinity for water, and its volume varies depending on ambient temperature and humidity. This variation causes pressure inside the sensor to rise and fall. In the worst case the electrolyte may leak out of the sensor and damage the circuitry around it.

To prevent this, the NT-CO-2F combines small size with an air vent capability. This maintains equilibrium between internal and external pressures and allows the sensor to be used in any orientation and under high temperature and humidity conditions.

Solderable

Conventional electrochemical sensors can not be soldered directly to pins because the rapid temperature increase causes thermal deformation of the plastic housing and subsequent leakage of electrolyte. The NT-CO-2F uses a unique electrode pin and socket design to dissipate heat and minimize the affect of high temperature. This simplifies the assembling process as the NT-CO-2F can be soldered directly to the PCB.



PERFORMANCE DATA

1) Linearity

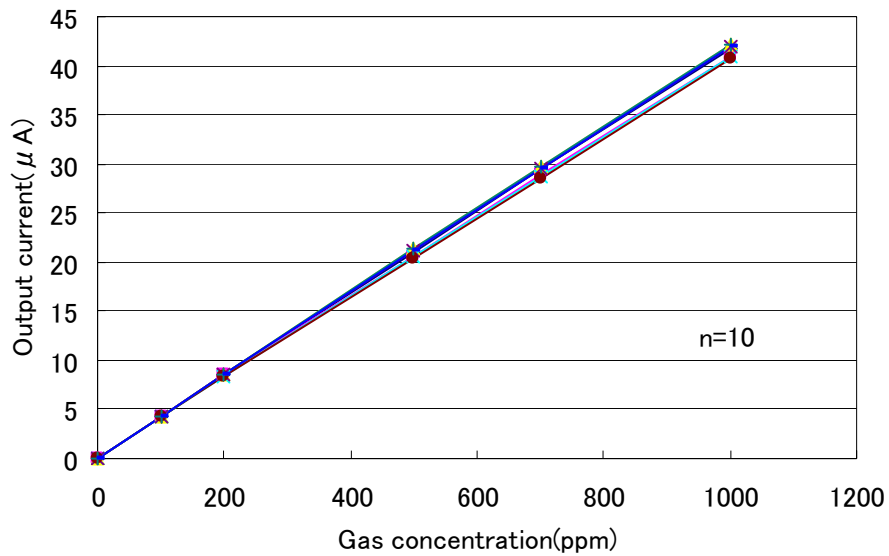

2) Uncompensated Temperature Dependence:

The following graph illustrates the typical effect of temperature on the output signal of the NT-CO-2F, for a sensor calibrated at 20°C

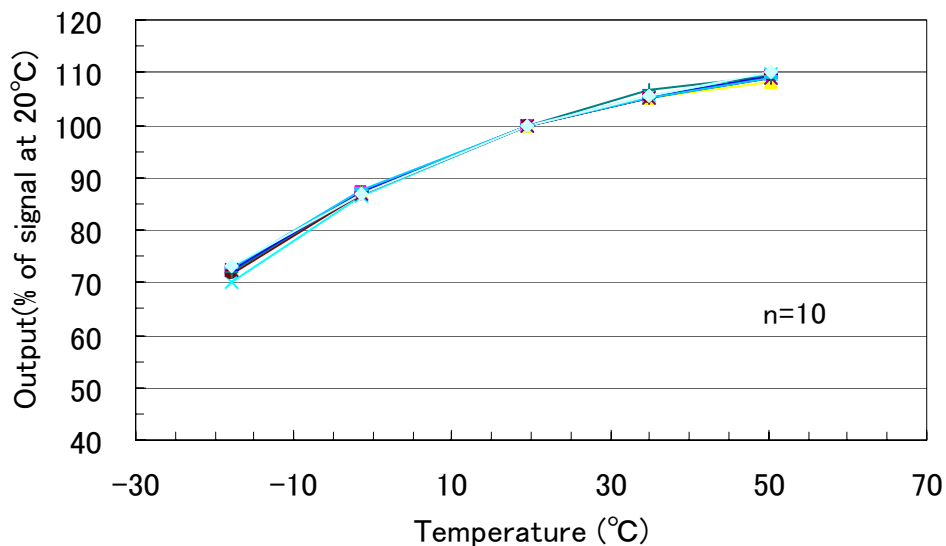

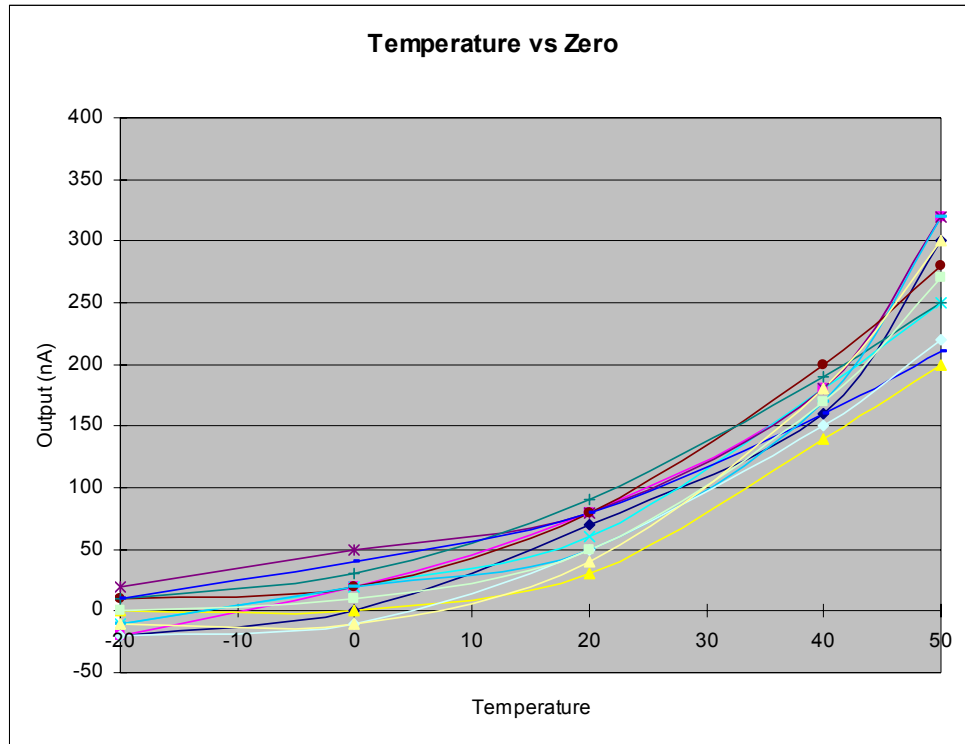

3) Cross Sensitivities:

The following table gives cross sensitivity information for a variety of commonly encountered gases.

Test gas	Gas Concentration Tested (ppm)	Typical carbon-monoxide reading (ppm) Equivalent
Carbon monoxide	100	100
Hydrogen	500	200
Methane	5000	0
Iso-butane	2500	0
Carbon dioxide	5000	0
Sulfur dioxide	25	0
Hydrogen sulfide	10	0
Nitrogen monoxide	30	0
Nitrogen dioxide	30	< 10
Ammonia	100	0
Ethyl acetate	200	0



4) Long Term Stability

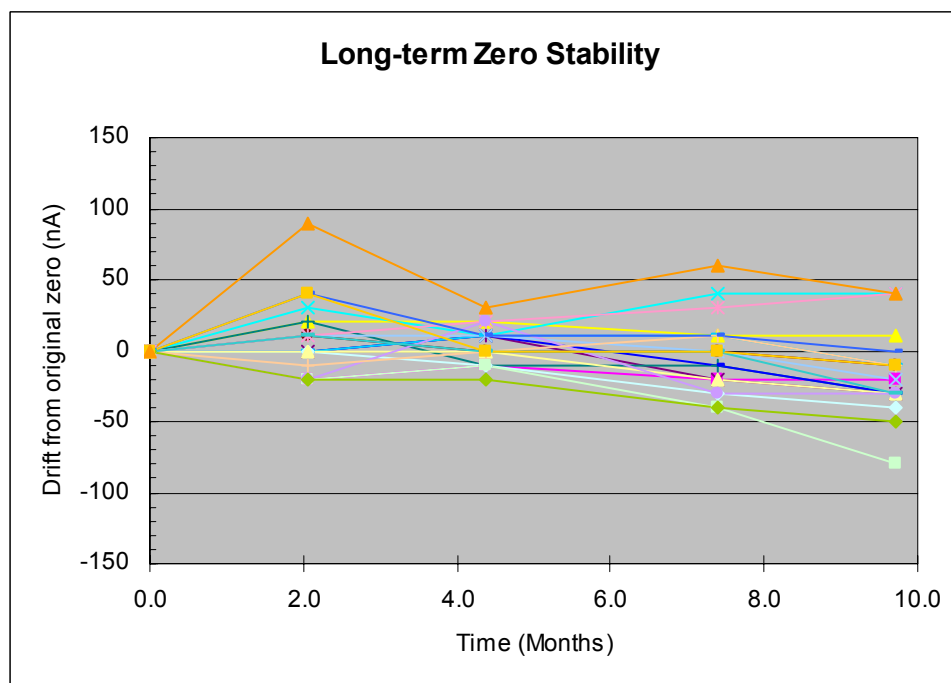
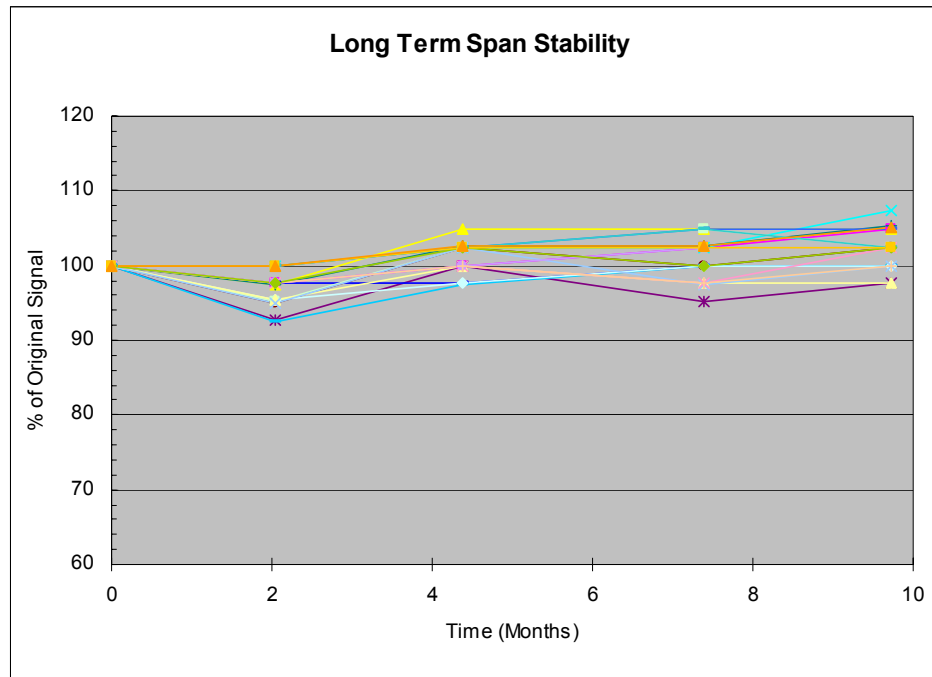



5) Output and Zero Distributions

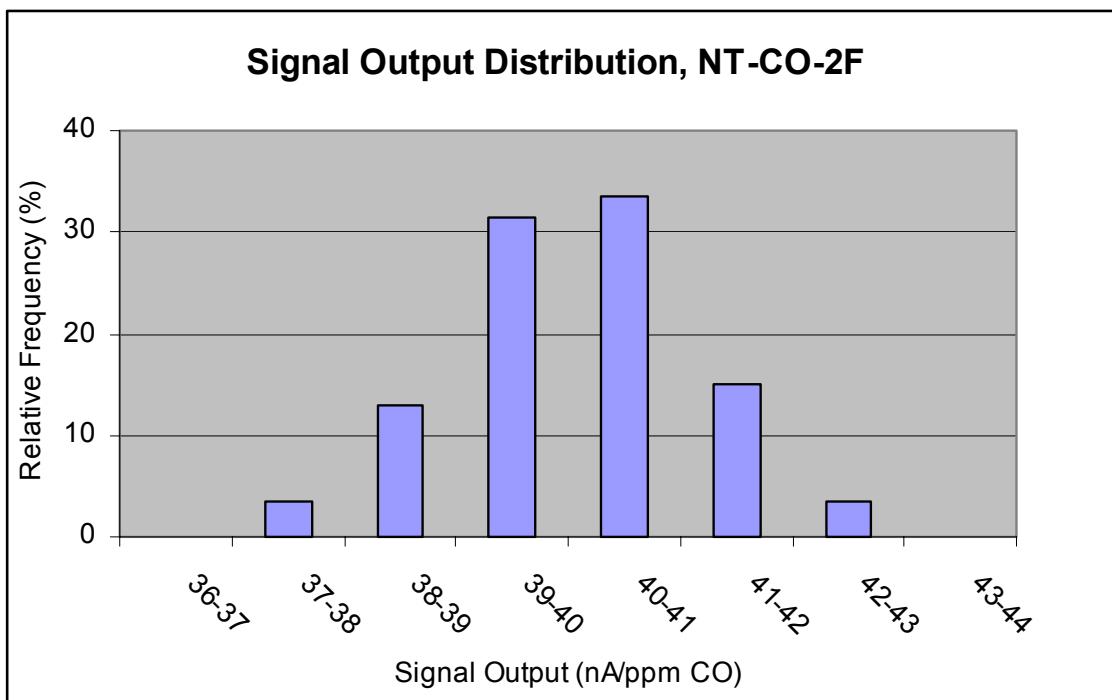
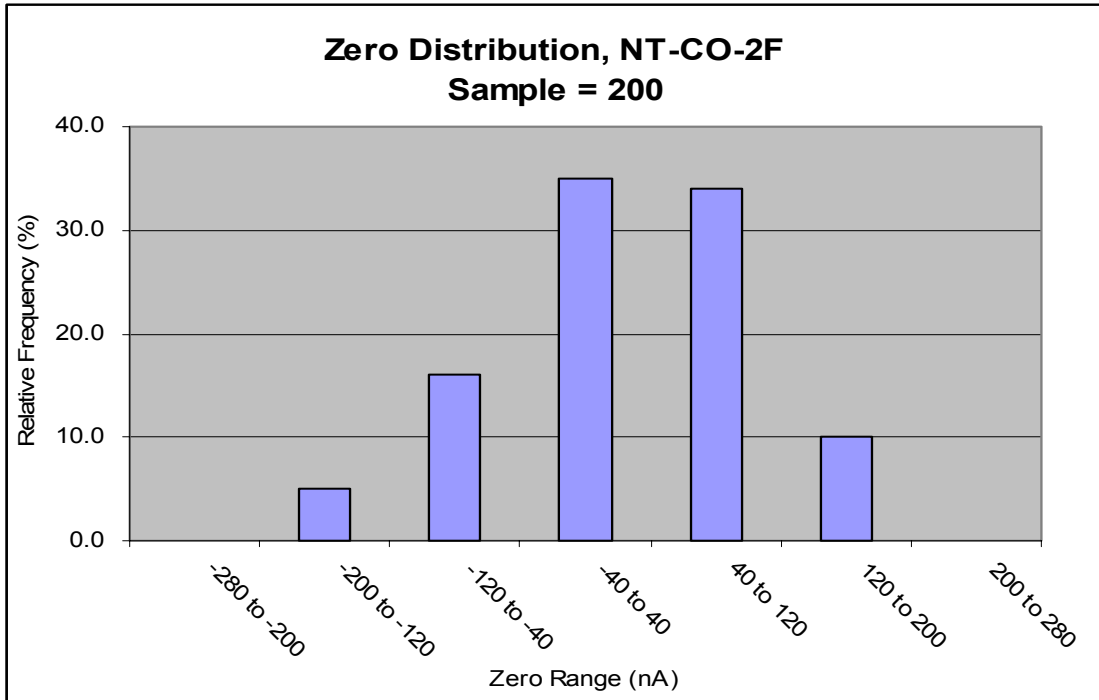



6) Environmental Tolerance and Ruggedness

The NT-CO-2F has been tested extensively to ensure that it can survive harsh environments and rough treatment, both in storage and during operation without failure or undue performance effects. A selection of the tests, with results, are outlined below:

<u>TEST</u>	<u>RESULTING OUTPUT DRIFT</u>
Storage at High Temperature: Sensor stored at 50°C, 40%RH for 1000 hours. Output signal tested against original at STP following storage	< +/- 15%
Storage at High Temperature/Humidity: Sensor stored at 50°C, 90%RH for 1000 hours. Output signal tested against original at STP following storage.	< +/- 10%
Storage at Low Temperature: Sensor stored at -20°C, for 1000 hours. Output signal tested against original at STP following storage	< +/- 5%
Storage at Low Humidity: Sensor stored at 25°C, <20%RH for 1000 hours. Output signal tested against original at STP following storage.	< +/- 10%
Cool/Heat Cycle: -20°C, for 30 minutes, +50°C for 30 minutes 10 cycles	< +/- 10%
Shock Test: Sensor dropped onto concrete floor from 1m height 5 drops	< +/- 5%

DEFINITIONS

Base-line / Base-line shift

Base line means the output level in clean air. The output current value at 20°C would be less than 250nA, but this tends to increase as the ambient temperature rises more than 30°C. The base-line shift means this variation of the output level, i.e. a maximum of approximately 350nA would be put out at 50°C. This base-line shift should be taken into account to optimise overall accuracy.

Gas sensitivity / Output signals

Using the NT-CO-2F, $40 \pm 10\text{nA}$ is generated at 1ppm of CO gas. For instance, the generated current value will be about $8\mu\text{A}$ at 200ppm of CO gas ($200\text{ppm} \times 40\text{nA}$). This generated current is generally recorded as a voltage produced by a Current – Voltage converting circuit. In our recommended circuit, as the conversion is done through a resistor of $10\text{K}\Omega$.

Response time (t_{90})

This is the time taken to reach to 90% of the maximum output value in clean air.



Repeatability

This is the maximum variation of output signals when tests are repeated under the same measuring conditions (temperature, humidity, gas concentration etc.). The repeatability of NT-CO-2F is $\pm 2\%$, and this means that all of the test results would fall in the range of 98% ~ 102%.

Temperature dependence

All electrochemical sensors are affected by changes in the ambient temperature and the output increases as the ambient temperature rises. This is caused by the rate of oxidation reaction on the surface of the catalyst, the dispersibility of the gas in the capillary, and the thermal affects on the mobility of ions in the electrolyte. This temperature dependency can be compensated relatively easily by using a NTC thermistor.

Recommended Circuit Suggestion

The following circuit includes for temperature correction using an NTC thermistor (TH). We are aware that many instrument designers have greater expertise in circuit design than we do, and so the circuit is for general guidance only and is not intended to be prescriptive.

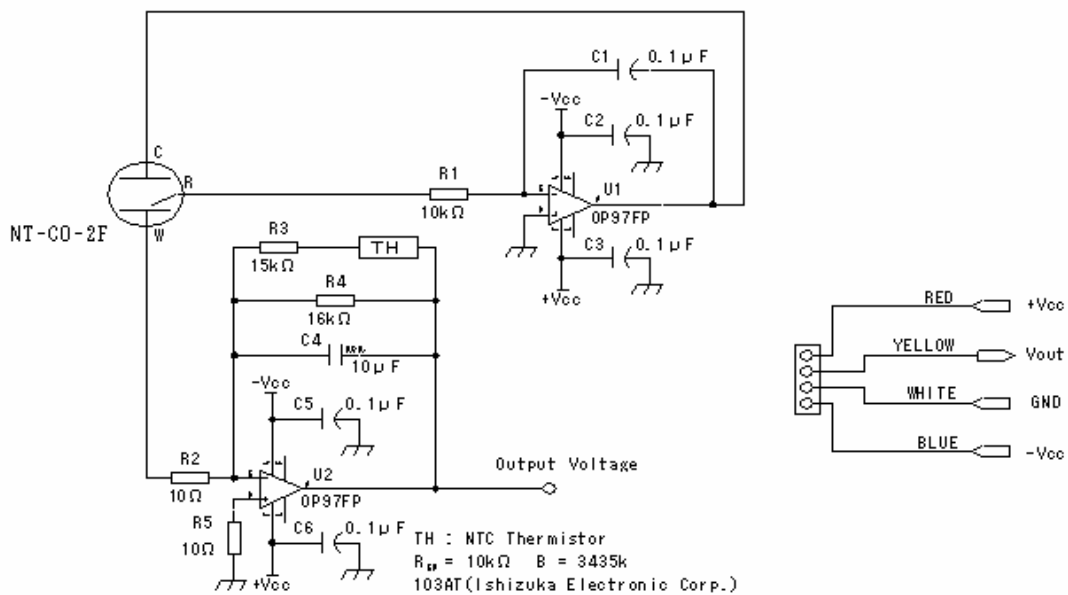



NOTES

1) Environmental affects on gas sensitivity

Due to the hygroscopic nature of the electrolyte used in electrochemical sensors, moisture is absorbed from or released to the surrounding atmosphere. In high humidity moisture is absorbed, causing an increased sensitivity. In low humidity moisture is released back to the atmosphere and the sensitivity decreases. Conventional electrochemical gas sensors show annual variation of gas sensitivity as much as 10 ~ 20%.

The NT-CO-2F utilises an advanced electrolyte management design and, combined with the unique electrode catalyst structure, these changes can be greatly reduced. Under normal operating conditions, gas sensitivity should change by no more than $\pm 5\%$ of the output value. The NT-CO-2F is designed so that all changes due to moisture uptake/release are completely reversible.

If the gas intake area of the sensor is blocked with water drops or other liquid, gas cannot enter the sensor. The NT-CO-2F is fitted with an integral hydrophobic barrier to prevent this, but we recommend the use of additional membrane barriers if the sensor is in highly condensing RH conditions.

CO gas is almost the same weight as air, but as it is a combustion by-product it will usually be heated and therefore rise. CO detecting devices should be installed at least 5ft from the floor and preferable on the upper part of walls or ceilings.

Under normal environmental conditions (room temperature and humidity), the warranty period for the NT-CO-2F is 1 year from the date of shipment.

If the sensor is to be used in more irregular atmospheres, please contact us for assistance.

2) Storage of sensors

Electrochemical sensors should be stored in a clean air under room temperature, preferably 0°C ~ 20°C and in non-condensing RH conditions. The maximum storage period would be 6 months after delivery. For sensors stored for more than 6 months, the performance guaranteed period will be shortened by the excess storage period. Unlike semiconductor type or hot-wire type gas sensors, the gas sensitivity of electrochemical gas sensors will change as time passes regardless of whether sensor has been used or not.

3) Mounting sensors

Electrode pins must be connected correctly to ensure operation.

If a thermistor is used for temperature compensation it should be located near the sensor and away from heat sources such as transformer.

NT-CO-2F can be mounted in any orientation.

NT-CO-2F pins can be soldered, but by manual soldering and the temperature of a soldering iron must be less than 350°C be applied for less than 3-seconds. Excess heating may cause the deformation of the housing and eventually leakage of electrolyte.

Refrain from using reflow soldering or solder bath with PCB's fitted with a sensor.



4) Calibration and gas testing

Calibration of detectors or densitometers should be done after the output value has been stabilized in clean air. Judgment of output stabilization depends on the required accuracy, but when the output comes down less than 5 mV (using our basic measuring circuit) it can be considered that the output has been stabilized.

Evaluation of gas sensitivity should be made in clean, humidified, air. When a test gas is blown directly to the gas intake area, higher gas sensitivity may be observed. It is therefore best to test and calibrate gas detection instruments and sensors in diffusion mode. This can be achieved by using a suitable test housing where a low flow rate is used (<1l/min) and where the air is agitated to ensure equal gas diffusion throughout.

5) Other

Unless otherwise advised by Nemoto, voltage should not be supplied directly to the electrode pins.

Do not bend the pins.

Do not apply more than 5 kgs/cm² to the sensor.

Take care not to block the gas intake area as it may prevent gas entering the sensor.

Never put foreign material in the gas intake area as it may cause the electrolyte leakage

Do not expose the sensor to excess vibration or shock.

If the sensor housing is damaged, do not use the sensor.

After the sensor is exposed to high concentration gas for long periods, the output signal may require time to recover to normal operation.

Do not blow organic solvents, paints, chemical agents, oils, or high concentration gases directly onto sensors.

Do not disassemble the sensor as this may cause electrolyte leakage.