

SB-30-04

FIS GAS SENSOR SB-30-04

for ALCOHOL DETECTION

The SB-30-04 is a tin dioxide semiconductor gas sensor which has a high sensitivity to alcohol with quick response speed. This model is suitable for alcohol detection such as portable breath alcohol checker or ignition locking system in automobiles.

Structure

Gas sensitive semiconductor material is a mini bead type and a heater coil and electrode wire are embedded in the element. The sensing element is installed in the metal housing which uses double stainless steel mesh (100 mesh) in the path of gas flow. The mesh is an anti-explosion feature (Fig1b).

Operating conditions

Fig 2 shows the standard operating circuit for this model. The change of the sensor resistance (R_S) is obtained as the change of the output voltage across the fixed or variable resistor (R_L). In order to obtain the best performance and specified characteristics, the values of the heater voltage (V_H) circuit voltage (V_C) and load resistance (R_L) must be within the range of values given in the standard operating conditions shown in the Specification table on the next page.

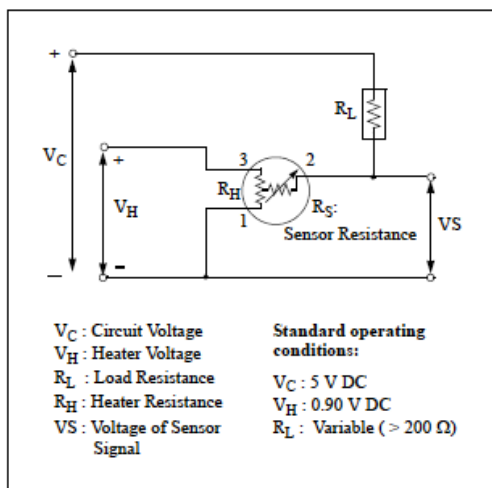

Fig 2. Standard circuit

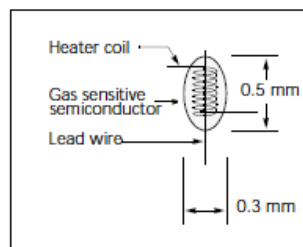

Fig 1a. Sensing element

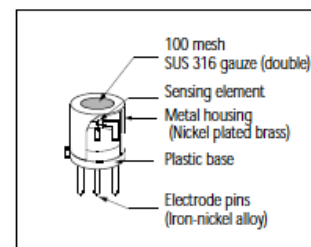

Fig 1b. Configuration

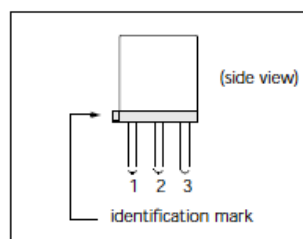

Fig 1c. Pin Layout

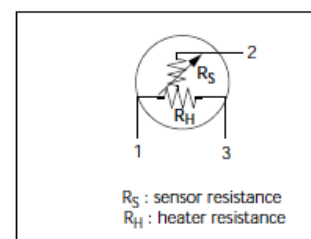

Fig 1d. Equivalent circuit

Sensitivity characteristics

Fig 3 shows the sensitivity characteristic curves of the SB-30-04 (typical data). Sensitivity characteristics of the FIS gas sensors are expressed by the relationship between the sensor resistance and gas concentration. The sensor resistance decreases with an increase of gas concentration based on a logarithmic function.

The sensitivity characteristics of the SB-30-04 is specified by the following parameters.

- Sensor resistance level: at 150 ppm of ethanol
- Sensor resistance change ratio: between ethanol 20ppm and 150 ppm

See the specification table on the next page for further details.

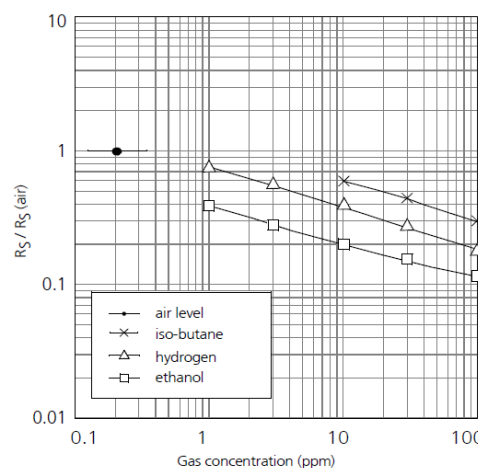

Fig3. Sensitivity characteristics

Specifications

A. Standard Operating conditions

| Symbol | Parameter | Specification | Conditions etc. |
|--------|--------------------------------------|---------------------------|------------------------------------|
| VH | Heater voltage | 0.9 V ± 0.05 V | AC, DC or pulse |
| VC | Circuit voltage | Less than 5 V | DC: Pin2 (+) - Pin 1 (-) |
| RL | Load resistance | Variable (> 200 Ω) | P _s < 10 mW |
| RH | Heater resistance | 2.8 Ω ± 0.2 Ω | at room temperature |
| IH | Heater current | 130mA (Typical value) | IH = VH / RH |
| PH | Heater power consumption | 120 mW (Typical value) | PH = VH ² / RH |
| PS | Power dissipation of sensing element | Less than 10mW | $P_s = \frac{(V_C - V_{RL})^2}{R}$ |

B. Environmental conditions

| Symbol | Parameter | Specification | Conditions etc. |
|-------------------|-----------------------|--|---|
| T _{ao} | Operating temperature | -10 °C to 50 °C | |
| T _{as} | Storage temp | -20 °C to 60 °C | |
| RH | Relative humidity | Less than 95%RH | |
| (O ₂) | Oxygen concentration | 21% ± 1% (Standard condition) | Absolute minimum level : more than 18%. |
| | | The sensitivity characteristics are influenced by the variation in oxygen concentration. Please consult FIS for details. | |

C. Sensitivity characteristics

| Model | SB-30-04 | | |
|---|-------------------|---------------|--|
| Symbol | Parameter | Specification | Conditions etc. |
| RS | Sensor resistance | 1 kΩ to 8kΩ | at ethanol 150ppm |
| β | Sensitivity | 0.35 to 0.55 | $\frac{R_s(\text{at ethanol } 150\text{ppm})}{R_s(\text{at ethanol } 20\text{ppm})}$ |
| Standard Test Conditions: Temp : 20°C±2°C VC : 5.0 V ± 1 % Humidity : 65%±5% VC : 0.9 V ± 1 % (in clean air) RL : 10 kΩ ± 5% Pre-heating time: more than 48 hours | | | |

D. Mechanical characteristics

| Items | Conditions | Specifications |
|-----------|-----------------------------|--|
| Vibration | Frequency : 5 - 500 Hz | Should satisfy the specifications shown in the sensitivity characteristics after test. |
| | Acceleration : 1.3 G | |
| | Sweep Time : 40 min. | |
| Drop | Height : 60 cm | |
| | Number of impacts : 3 times | |

Dimensions

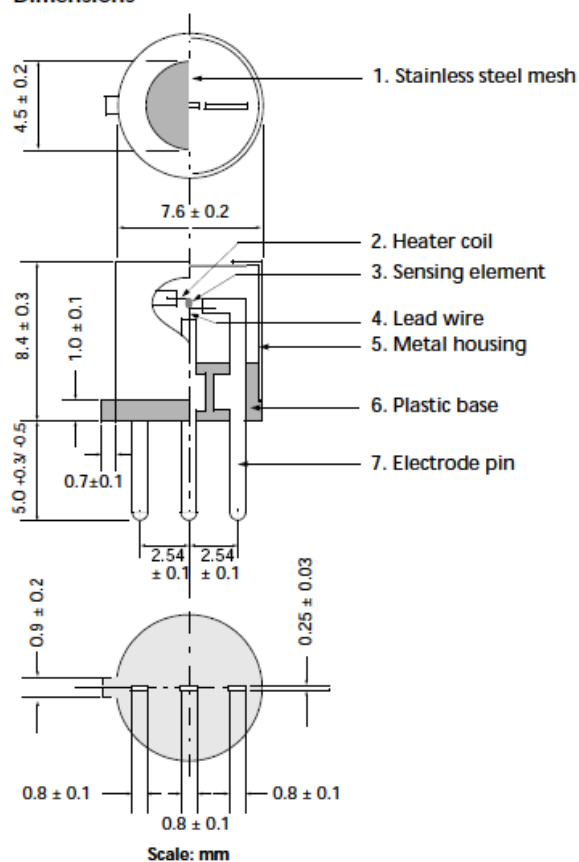

Weight : 0.6g

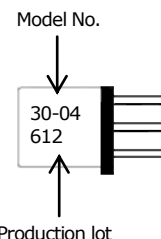

E. Parts and Materials

| No. | Parts | Materials |
|-----|----------------------|----------------------------|
| 1 | Stainless steel mesh | SUS 316 (100 mesh, double) |
| 2 | Heater coil | Platinum |
| 3 | Sensing element | Tin dioxide |
| 4 | Lead wire | Platinum |
| 5 | Metal housing | Nickel plated brass |
| 6 | Plastic base | PBT (GF30%) |
| 7 | Electrode pin | Iron-nickel alloy |

Please contact

In the interest of continued product improvement, we reserve the right to change design features without prior notice.

MARCH, 2017

FIS Inc.
3-36-3, Kitazono
Itami, Hyogo
664-0891 Japan

Tel: +81-72-780-1800
Fax: +81-72-785-0073
<http://www.fisinc.co.jp>